



OBLAK

A DOOR AND WINDOW COMPANY



ABOUT US

With a vision for the future and with high quality and technology standards, Oblak is a leading company in Argentina which offers a whole and innovative system of doors and windows over more than 50 years.

OUR LEGACY

Oblak company is a family affair. Our history began in 1950 with three remarkable brothers who set their initial industry on the outskirts of Buenos Aires. They emigrated from Slovenia, a country situated in the heart of Europe, and decided to start manufacturing wooden doors and windows taking advantage of their solid knowledge of the raw material and their skills at woodworking and handcrafting.

This decision quickly showed good results. They started to offer high quality products and their work formed the foundation of a solid and steady growing company that we know today.

That initial small industry has turned over the years into a leading company where its products are developed with the highest manufacturing standards and are the best of the local industry.

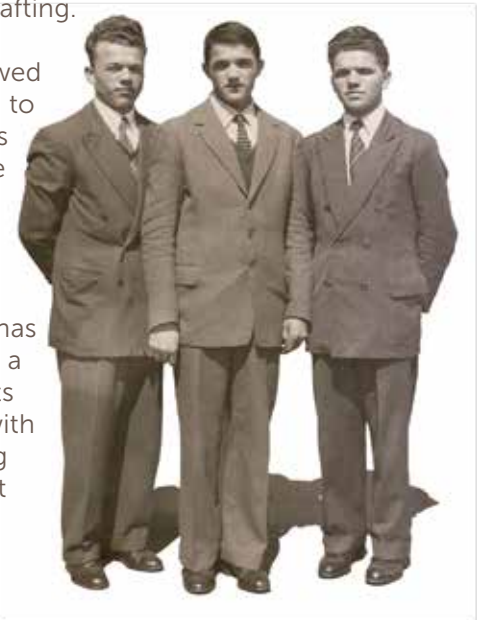





OUR MISSION – WHAT WE DO

Our daily work is focused upon developing and manufacturing the most complete and innovative set of products. This is the essence of our company and is reflected in our wide range of products.

We are highly committed to satisfying market demands, actively seeking our client satisfaction.

MAKING THE DIFFERENCE – HOW WE DO IT

We aim to bring differentiated, high-quality products using the latest technology and excellent materials with our professional and technical know-how and talented people.

OUR HEADQUARTERS

We have the capacity to manufacture more than 500,000 units per year with more than 300 employees. Our headquarters is in the province of Buenos Aires, Argentina and is surrounded by a land of 44 acres where the factory occupies 452.084 ft².

Each of our manufacturing process is carried out in compliance with environmental laws. Factory machines operate under European standards and all the wood we use comes from forest plantations.



OUR PRODUCTS

Our products are delivered from our headquarters through a wide distribution network; and they can be purchased throughout Argentina and in several countries of the continent.

OUR COMMITMENT

More than 50 years since we began, we remain just as committed to and passionate about advanced products that offer quality and satisfaction to our clients.

Every day we are challenged, and innovation has always been an inspiration to us all. We are proud of our history and therefore committed to continue offering products with the highest standards of manufacturing.

SUSTAINABILITY

OBLAK is committed to more sustainable business practices and environmental stewardship. This affects every aspect of our organisation and governs our approach to energy efficiency, air and water emissions and indoor air quality.



scan to see our
institutional video

INTERIOR DOORS

Our interior door collection is the perfect solution for our clients with the building, update or refurbishment of their home. This collection is stylish with innovative designs. There is a door that suits every taste.

These products have an added value by reducing time and scheduling in the construction process.



TEKSTURA™ Series



ROUTED MASTER™ Series



PRACTIKA™ Series



TEKSTURA™ Series

A line of interior doors, manufactured with two 5.5 mm MDF – medium density fibreboard – boards, enhanced with a melamine resin coating.

This collection is available in three different models and four-color patterns.

TEKSTURA™ Series

TEKS FLUSH



READY TO USE

- Finished door, ready to install.



MAINTENANCE LEVEL

- Free maintenance because of the manufacturing materials and technology.



FINISHING

- Four different wood patterns.
 - Walnut
 - Nevada
 - Wengue
 - Natural Oak



TECHNICAL INFORMATION

- Door is manufactured with two 5.5 mm MDF – medium density fibreboard – boards which are glued and pressed to a stabilized finger joint wooden frame. It has a corrugated honeycomb cell core.

- Modern designs with aluminum inserts and tempered glass.

- Lateral edges coated in PVC badges.

- Width of door: from 24" to 42".

- Height of door: from 80" to 96".

- Thickness of door: 1 3/8".



Walnut

Nevada

Wengue

Natural Oak

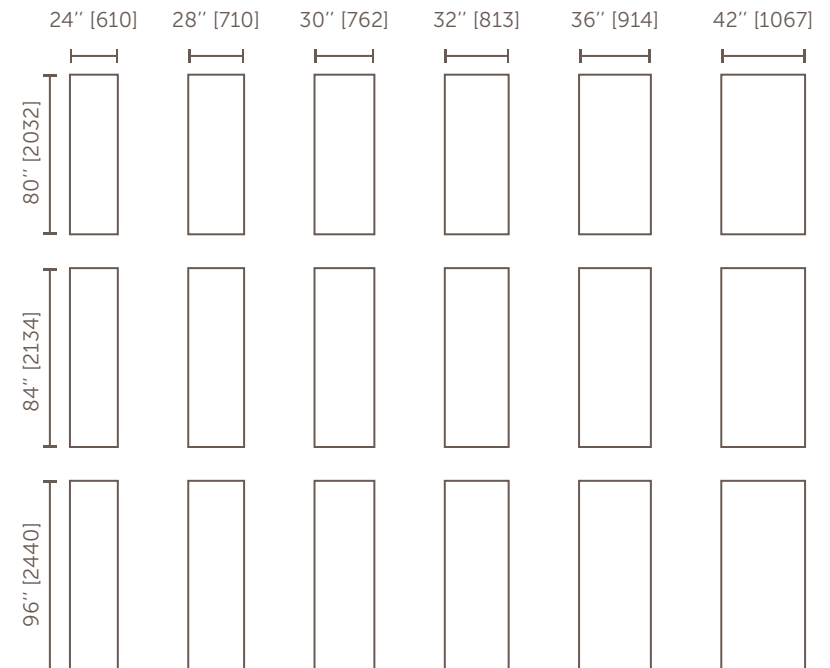

TEKS H



Walnut aluminum

Nevada aluminum

Wengue aluminum

Natural Oak aluminum

TEKS Q



Walnut tempered glass

Nevada tempered glass

Wengue tempered glass

Natural Oak tempered glass

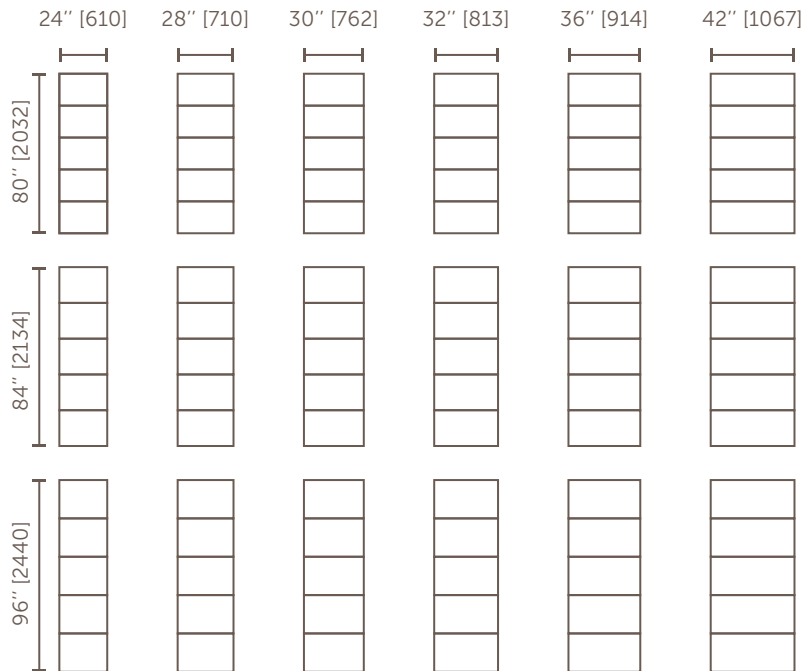



ROUTED MASTER™ Series

Molded panel door collection with innovative design to update the style of any home.

A collection that brings innovation and design.

ROUTED MASTER™ Series

ROUTED MASTER CAPRI



FINISHING

- Available in primed white.
- Primed doors give you the design flexibility to choose any finish color.



MAINTENANCE LEVEL

- Primed door and ready to start the painting process.



TECHNICAL INFORMATION

- Manufactured with two 9.9 mm MDF boards.
- Routed carved doors.
- Solid wood edges for easy and safe installation of hinges.
- Corrugated honeycomb cell core.
- Smooth surfaced door primed in white paint.
- Available with molding kits.
- Width of door: from 24" to 42".
- Height of door: from 80" to 96".
- Thickness of door: 1 3/8".



Two squared raised panels

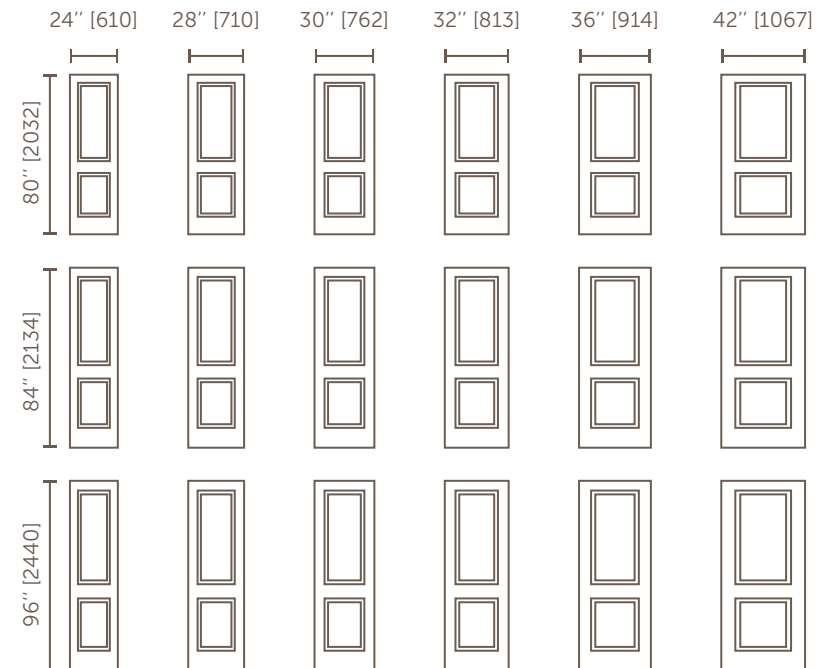

ROUTED MASTER DOMMO H



Four horizontal grooves

ROUTED MASTER DOMMO V

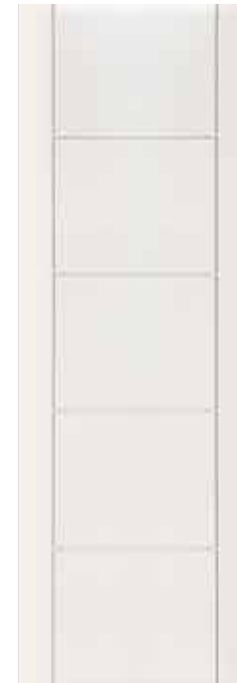

Two vertical panels with five central panels

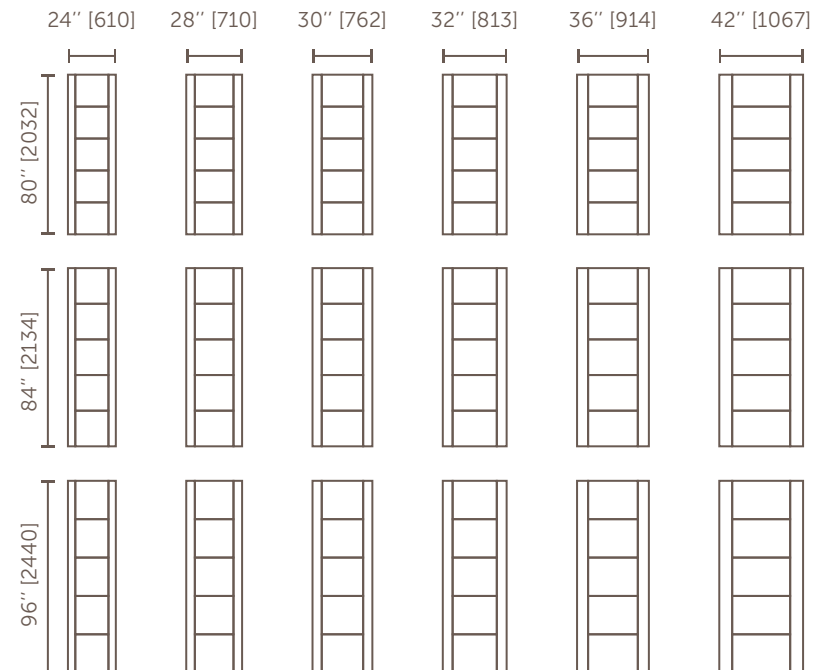
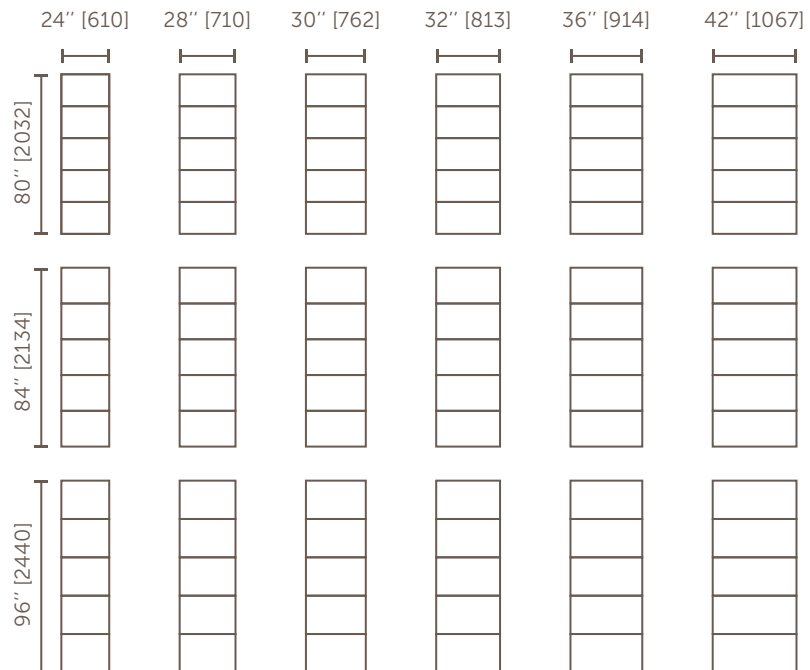

A photograph of a white door in a modern kitchen. The door is centered in the frame, set within a white frame. To the left, a kitchen counter with a light-colored countertop and white cabinets is visible. To the right, a dark kitchen island with a white countertop is partially seen. The floor is made of light-colored wood. The background wall is a neutral color, and there are some electrical outlets and switches visible. The lighting is soft and even.

PRACTIKA™ Series

A collection of interior doors manufactured with two 2.7 mm MDF – medium density fibreboard - boards which are glued and pressed to a solid wood frame with a corrugated honeycomb cell core.

PRACTIKA™ Series

PRACTIKA



READY TO USE

- Finished door, easy to install.



MAINTENANCE LEVEL

- Free maintenance because of the manufacturing materials and technology.



FINISHING

- Available in two different colors
 - Cedar
 - Simple and smooth white.



TECHNICAL INFORMATION

- Door is manufactured with two 2.7 mm MDF boards which are glued and pressed to a rails wooden frame and have a corrugated honeycomb cell core.

- Both faces are laminated in decorative melamine foil glued with PUR, in two different colors. Upon client request, any desirable color can be manufactured.

- Lateral edges covered with PVC badges.
- Width of door: from 24" to 42".
- Height of door: from 80" to 96".
- Thickness of door: 1 3/8".



Cedar

White

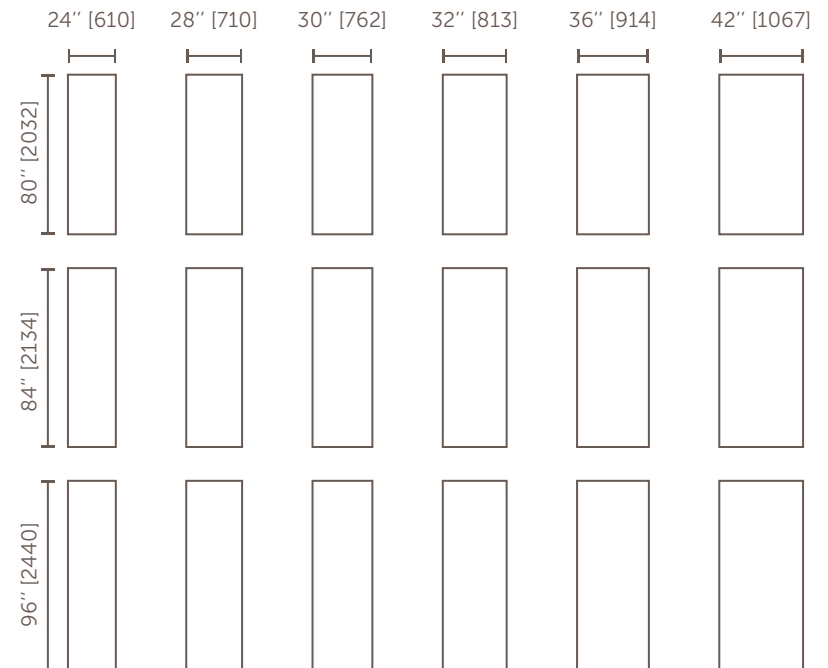

OUR FLAT JAMB

We offer the traditional flat jamb that comes in two pieces.

These pieces overlap slightly to adjust the flat jamb to wall thickness.

The kit of flat jamb is made of raw finger-joint clear pine.

There are three finishing available:

- Laminated in melamine foil.
- Primed white.
- Natural finger clear pine.

All of them fit with TEKSTURA, ROUTED MASTER and PRACTIKA Series doors.

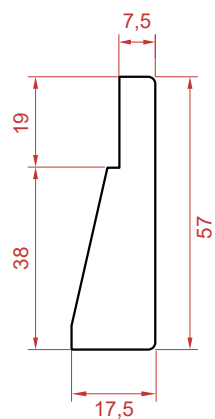
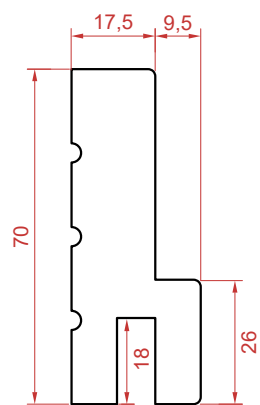

TEKSTURA™
Series



ROUTED MASTER™
Series



PRACTIKA™
Series



OBLAK NEW ADJUSTABLE FRAME

Following our commitment to find solutions for our clients, Oblak designed a new wooden frame to reduce installation time and which perfectly matches to your door.

The frame kit includes the wooden frame which is laminated in melamine foil together with six wood pieces also laminated in the same melamine foil.

Adjustable frames can be easily adjusted to any wall thickness with an integral extension with up to 0.787 inches fitting tolerance.

This is a perfect solution to installation process.

ADJUSTABLE FRAME 10 cm

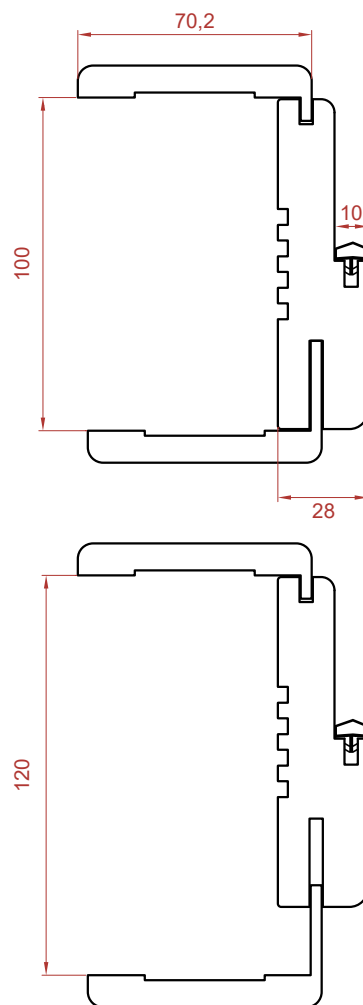

TEKSTURA™ Series





OBLAK HNOS. S.A.C.I.F. e I.
Ruta Nac. N° 3, Km. 38 (B1763BYA)
Virrey del Pino - Pcia. de Bs. As. - Argentina.
Tel.: (54) 02202-494000

Fax Adm.: (54) 02202-499192
Fax Ventas: (54) 0810-345-6252
e-mail: info@oblak.com.ar
www.oblak.com.ar